



LAMILUX GLASS SKYLIGHTS

DAYLIGHT FOR A SENSE OF WELL-BEING

FIND THE OPTIMUM GLASS SKYLIGHT FOR YOUR CONSTRUCTION PROJECT

"You can find the best flat skylight for your project with us – this is our claim. Our skylights combine high energetic qualities, modern and attractive designs, durability and functionality even in extreme weather conditions, simple installation and optimal renovation solutions. Only when everyone on the construction site and in the building is satisfied with our Glass Skylights are we satisfied!"

Michael Blechschmidt Head of Sales Skylights



The LAMILUX CI Philosophy

Customer value is the reason we exist – and the focus of our activities. This requires harmony, identity and a balance between customer value and company strategy.

The principles that guide our company's actions and customer relations are set out in LAMILUX's company philosophy:

Customized Intelligence – serving customers is our first priority: This requires outstanding performance and leadership in all areas relevant to customers, particularly in the role of:

- A leader in quality – optimum benefit for customers
- A leader in innovation – at the cutting edge of technology
- A leader in service – fast, uncomplicated and friendly
- A leader in expertise – optimum sales and technical advisory services
- A leader in problem solving – individual, tailored solutions



CONTENT

LAMILUX Glass Skylight F100

Product description
Product variants
References

Page 4
Page 10
Page 12

LAMILUX Glass Skylight FE

Product description
Product variants
References

Page 14
Page 18
Page 26

LAMILUX Flat Roof Access Hatch Comfort

Page 28

LAMILUX Glass Skylight FIRE RESISTANCE

Page 30

Smoke and heat exhaust ventilation

Page 34

Features

Page 38

LAMILUX

GLASS SKYLIGHT F100

The LAMILUX Glass Skylight F100 is an energy-efficient skylight for rooms with high optical demands. Particularly in residential, administrative and office buildings, it floods rooms with daylight and fresh air. Various shading options can be used to control the amount of light and heat entering the room – conveniently controlled for a comfortable climate.

Not only the building user, but also the builder benefits from tangible, practical advantages: The element is very quick and easy to install. It is completely pre-assembled on the upstand when it is delivered to the construction site and it can be installed on the flat roof immediately – both the ventilated and the fixed variant.

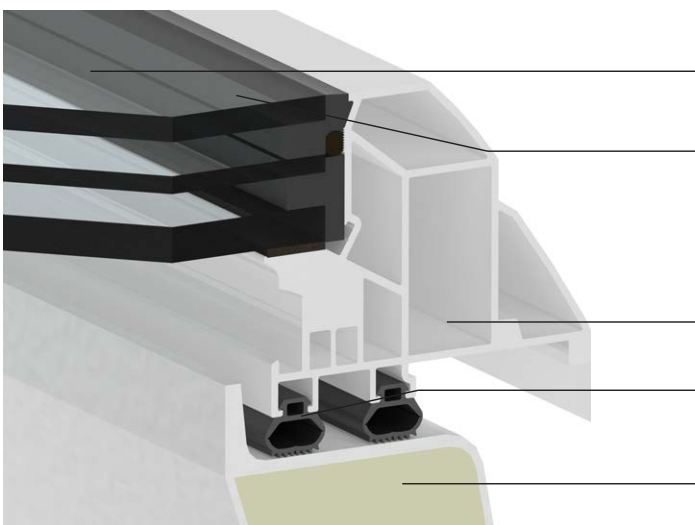

First Glass Skylight with national technical approval featuring a **"Structural-Glazing design"**

Flat drainage surface: The unique frame profile provides a smooth transition between the glazing and the border frame, creating an unobstructed drain for rainwater

Thermally optimised PVC border frame

Outstanding, certified air-tightness due to the balloon double sealing system

Heat-insulated upstand made of glass-fibre reinforced composite: Manufactured without joints and (optional) with a continuous insulation core made of PU foam, 60 mm thick; optional ventilation drives concealed in the upstand

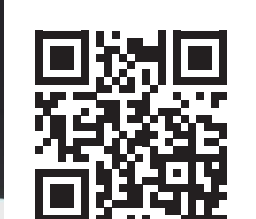

See in this video how the LAMILUX Glass Skylight F100 makes your project even more successful



 **ENERGY EFFICIENCY**

Savings on heating costs and minimised risk of condensation thanks to flawless isothermal characteristics

All-round optimum thermal insulation in a compact, thermal-bridgefree overall system

Preservation of thermal energy in the building thanks to the tight overall system

Seamless and waterproof upstand made of glass-fibre reinforced composite with integrated insulation

 **COMFORT & DESIGN**

Optional drive units integrated invisibly in the upstand

Avoidance of internal plastering work thanks to smooth, silk-white interior finish of the upstand

Permanently clear view, infinitely variable water drainage and generous daylight incidence due to scratch-resistant glazing and uniquely designed frame profile

Optional simplification of connection work through optimum structural attachments for a wide variety of sealing techniques

 **FUNCTIONALITY IN EXTREME WEATHER EVENTS**

Tested watertightness in heavy rain and during storms (impervious to driving rain, in accordance with DIN EN 12208, Class E 1950)

Optimised sound insulation and minimised rain noise due to special glazing ($R_w = 38$ dB)

High stability against wind and snow loads (wind load – class C4 according to DIN EN 12210)

Optional internal or external shading as well as UV-resistant edge seal against strong solar radiation

 **SAFETY**

Approved fall-through protection according to GS-Bau 18

Preventive fire protection according to DIN 18234: Prevents fire spreading on the roof without additional measures

Use as a smoke outlet in stairwells

Available as qualified smoke and heat exhaust ventilation device according to DIN 12101-2



STRUCTURAL GLAZING DESIGN

The LAMILUX Glass Skylight F100 is the first skylight in a structural glazing design to be approved by the building authorities. The joining technology originates from façade construction. This means that the glass panes are attached to the supporting system without any visible fixtures. The resulting glass and frame unit makes the LAMILUX Glass Skylight F100 not only visually attractive but also extremely resistant to wind loads.

The structural glazing edge bond makes it possible to install the flat roof window in coastal regions in buildings up to 25 metres high which are subjected to high prevailing wind loads. Continuous, even water drainage from the element is also guaranteed which prevents build-up of dirt around the edges or accumulation of rainwater. Instead, the running water removes any dust and dirt from the panes.

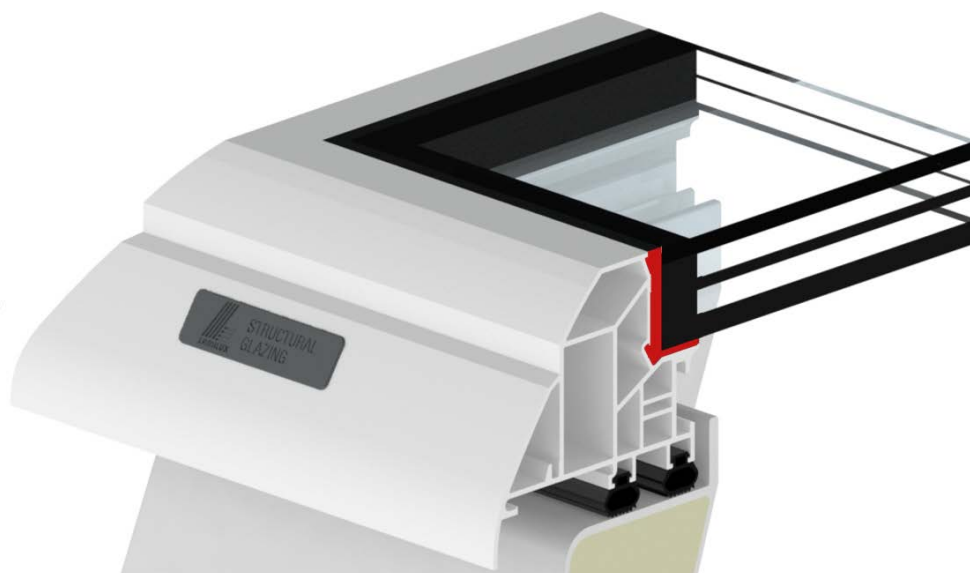



LAMILUX

GLASS SKYLIGHT F100 CIRCULAR

LAMILUX was the first manufacturer to shape the PVC border frame of a flat roof window into a round element. The element is also very flexible with regard to size: with an upstand height of 30, 50 or 70 cm and a diameter of 60 to 180 cm, it is suitable for all types of buildings and provides concentrated, atmospheric natural light. For its innovative and sophisticated design, the Glass Skylight F100 Circular has already received two awards: The Red Dot Award and the German Design Award. This shows that: For all those who wish to set the light stage and who have high standards when it comes to design and state-of-the-art technology, the new Glass Skylight F100 is an excellent solution.

LAMILUX offers chain drives for the Glass Skylights F100 Circular with a diameter of 120 cm and 150 cm, which are invisibly integrated into the upstand. This ensures an architecturally attractive interior and exterior view without any distracting ventilation units and triumphed as the German Design Award Winner 2020. With a lifting height of 150 mm, the chain drive ensures sufficient fresh air inside the building. The structural glazing design and the optionally available 5° integrated incline ensures rainwater can run-off easily.

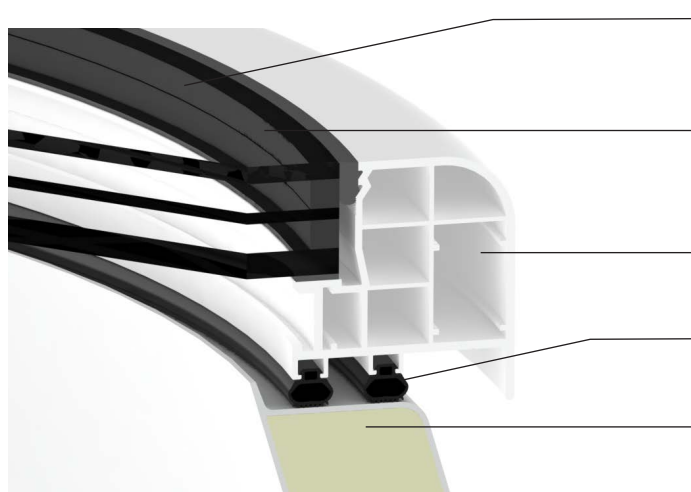

Structural Glazing design

Flat drainage surface: The unique frame profile provides a smooth transition between the glazing and the border frame, creating an unobstructed drain for rainwater

Thermally optimised PVC border frame

Outstanding, certified air-tightness due to the balloon double sealing system

Thermally insulated upstand made of glass-fibre-reinforced composite: Manufactured without joints (optional) and with a continuous insulation core made of PU foam, 50 mm thick



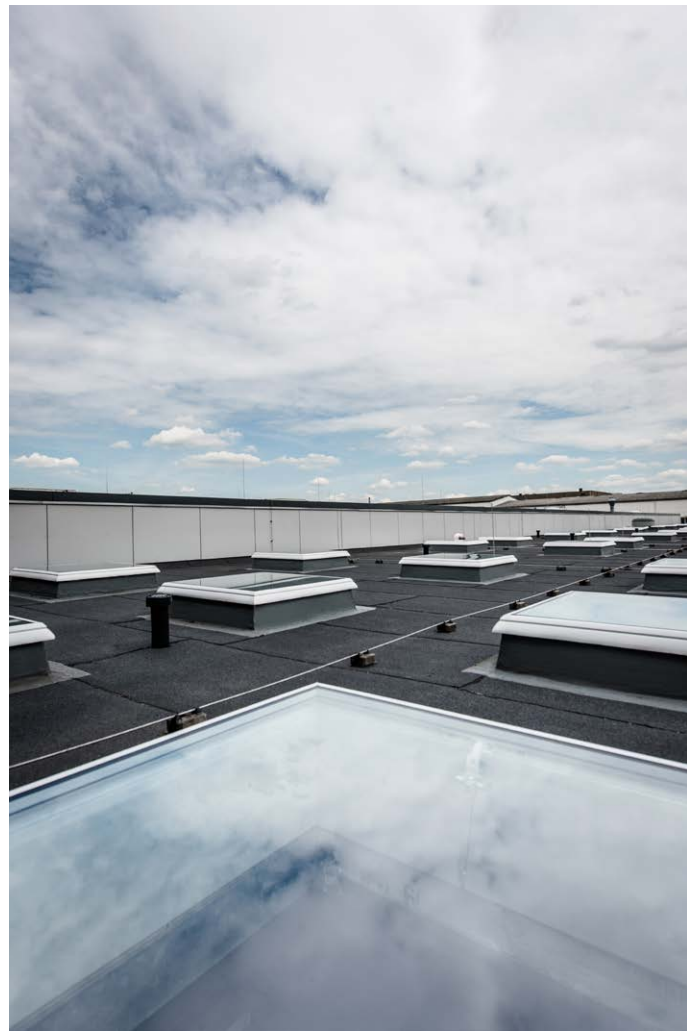

LEGIENDAMM, BERLIN

Project:

Creation of an interior design, attractive daylight solution in the living area: Illumination of the rooms with one square and two circular LAMILUX Glass Skylights F100.

Use of ventilated elements for daily aeration and ventilation

Systems:

- LAMILUX Glass Skylight F100 Circular
- LAMILUX Glass Skylight F100

CARITAS, HAGEN

Project:

Renovation of the roof of the Caritas workshop for people with disabilities: Natural illumination of the premises with around 70 LAMILUX Glass Skylights F100.

Avoidance of dirty edges and water ponding due to flush glazing in the border frame ensuring rainwater can run-off

Systems:

- LAMILUX Glass Skylight F100
- LAMILUX Glass Skylight FE



WORKSHOPS, STRAUBING

Project:

Modernisation of a workshop building with over 120 LAMILUX Glass Skylight F100
 Increase of natural daylight and reduction of running energy costs

Systems:

- LAMILUX Glass Skylights F100 in different sizes
- Interior sun protection



HÖÖR SCHOOL, SWEDEN

Project:

Illumination of the school corridor of the Waldorf School in southern Sweden with a 120 x 120 cm LAMILUX Glass Skylights F100
 Significant reduction in energy requirements in the corridor area

Systems:

- LAMILUX Glass Skylight F100

LAMILUX

GLASS SKYLIGHT FE

Sophisticated design in a number of variants: the redevelopment of the LAMILUX Glass Skylight FE represents a new milestone in product development at LAMILUX. Architects, builders and building users benefit from an innovative frame profile and sophisticated design features with a wealth of additional benefits. The Skylight received the 2019 German Design Award, the Red Dot Design Award and the Plus X-Award.

The design of the new LAMILUX Glass Skylight FE can also be adapted to any construction project's overall architectural concept. Design freedom is offered, for example, a wide variety of glazing and sizes up to 2.5 x 2.5 metres, the concealed drive in the profile frame and the freely selectable exterior and interior colours of the skylight. It also impresses with its all-round optimum thermal insulation in a compact, thermal bridge-free overall system with certification in the Passivhaus class pHc.

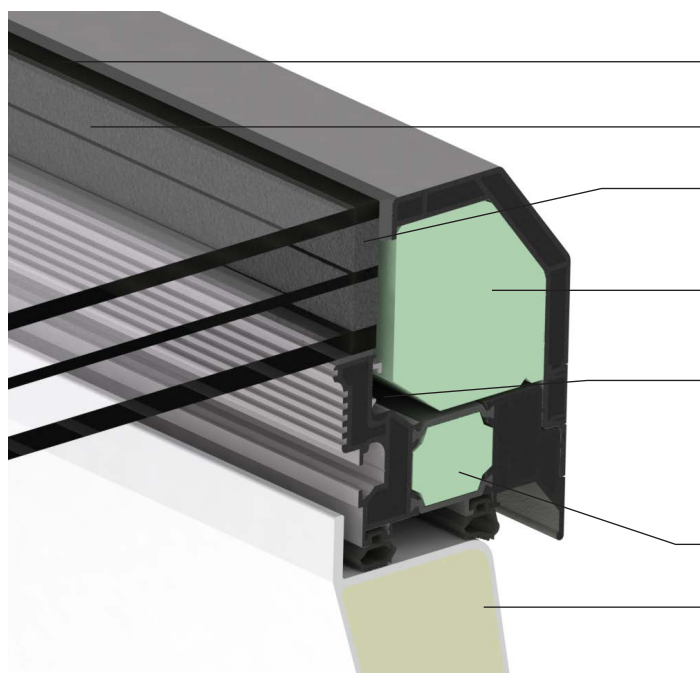

Structural Glazing design

Flat drainage surface

"Warm edge" (spacers between the panes, made of materials with low thermal conductivity) **as a standard feature**

Integration of all drives and components in the profile frame

TAD – Thermo active design: A patented component below the glazing support for surface enlargement absorbs more heat energy from the room air and thus contributes to the optimised isothermal curve

Insulated frame profile with thermally optimised insulation core

Heat-insulated upstand made of glass-fibre reinforced composite: Manufactured without joints (optional) and with a continuous insulation core made of PU foam, 60 mm thick

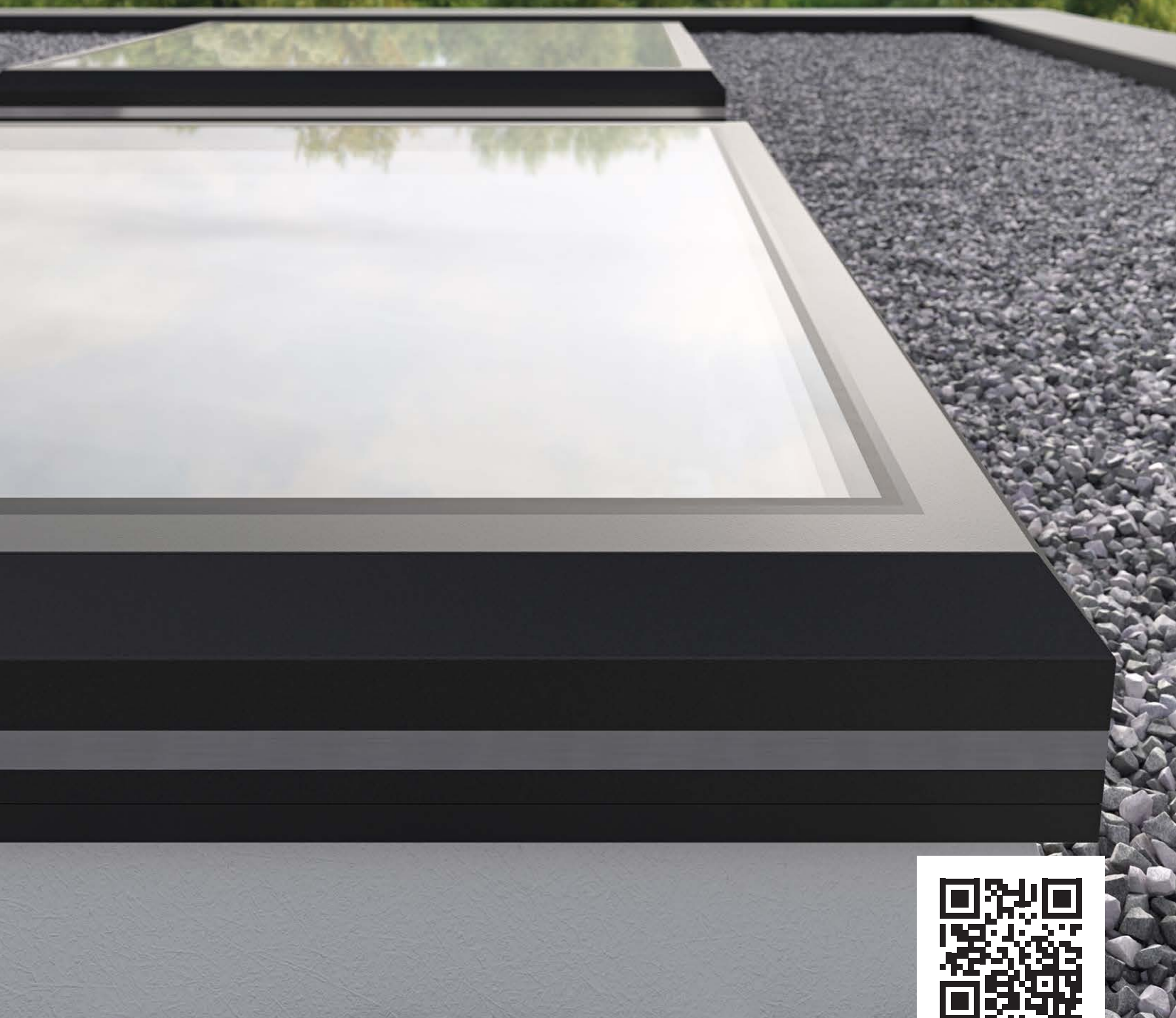



ENERGY EFFICIENCY

Savings on heating costs and minimised risk of condensation thanks to flawless isothermal characteristics

All-round optimum thermal insulation in a compact, thermal-bridge-free overall system with certification in the passive house class pHc

Preservation of a lot of thermal energy in the building thanks to the tight overall system

Seamless and waterproof upstand made of glass-fibre reinforced composite with integrated insulation

COMFORT & DESIGN

Uniform appearance throughout thanks to new joining technology: no visible screw joints or weld seams as well as four-sided flat water drain

Easy installation thanks to completely pre-assembled delivery of the skylight

The integration of all drives, power adapters, cables and other components into the frame of the skylight creates a smooth interior design

Variety of design and colours thanks to freely selectable exterior and interior colours of the Glass Skylight

FUNCTIONALITY IN EXTREME WEATHER EVENTS

Tested watertightness in heavy rain and during storms (highly impervious to driving rain, in accordance with DIN EN 12208, Class E 1950)

High stability against wind load (highest wind load class C5 according to DIN EN 12210)

Excellent air permeability (performance class 4 – EN 12207)

Optimised sound insulation and minimised rain noise due to special glazing ($R_w = 38$ dB)

SAFETY

Approved fall-through protection according to DIN 18008-6

Preventive fire protection according to DIN 18234: Prevents fire spreading on the roof without additional measures

Use as a smoke outlet in stairwells

High hail resistance due to standard TSG outer pane



LAMILUX

GLASS SKYLIGHT FE 3°

The LAMILUX Glass Skylight FE 3° is an attractive individual element for the flat roof. It creates all aspects of modern, energy-efficient and design-oriented construction and achieves sophisticated architectural ideas. Additional accessories such as sun protection or shading roller blinds are also available with this system, which can be integrated in both residential and commercial buildings.

Water and dirt run off naturally on the 3° inclined upper part with a stepless transition between the frame profile and glazing. The complete system, which is free of thermal bridges, has core insulation in the frame profile as well as glazing with a warm edge design, thus ensuring high energy efficiency. The outstanding certified air tightness of the skylight is achieved by a double seal.

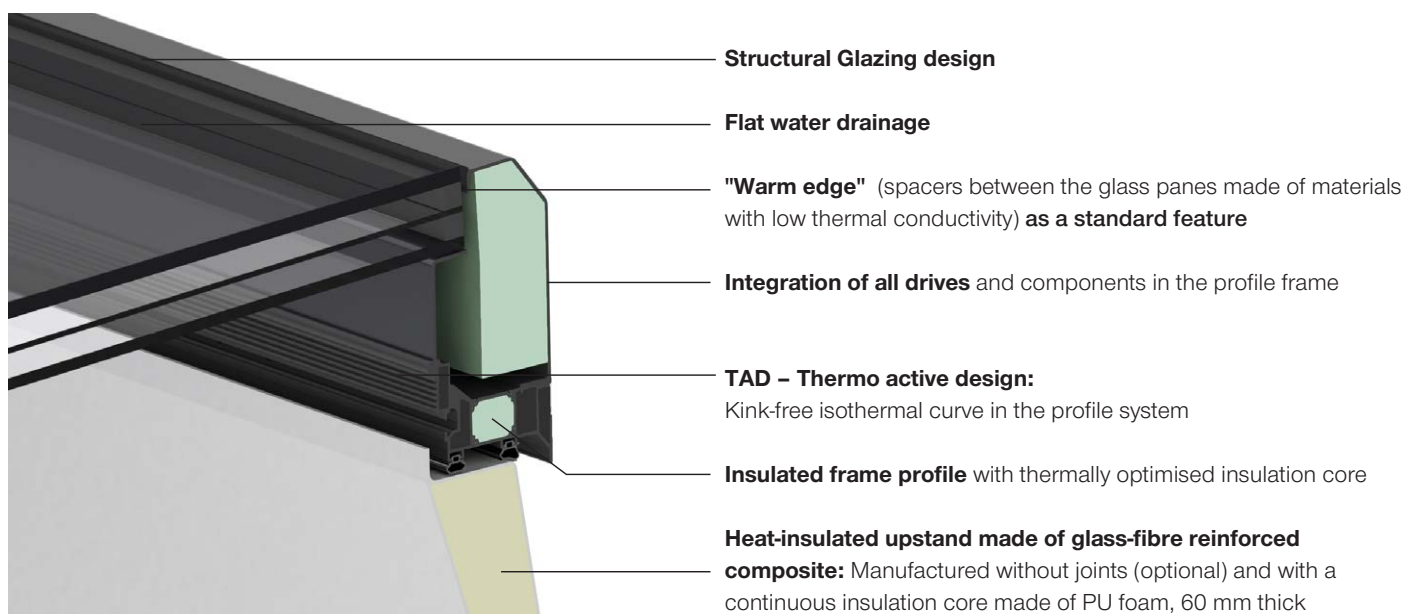



LAMILUX

GLASS SKYLIGHT FE CIRCULAR

The LAMILUX Glass Skylight FE Circular stands for high aesthetic demands. The daylight element meets the highest expectations for the modern design of buildings both in administrative buildings and in private residential and house construction. And the energetic qualities are also convincing, as are the high-grade workmanship and the high incidence of daylight.

The round, elegant frame profile is smooth and works without joints and can be coated in all customer-specific colours according to the RAL scale. The LAMILUX Glass Skylight FE Circular is the perfect skylight where round shapes and high-quality materials enhance the overall visual impression of a building.

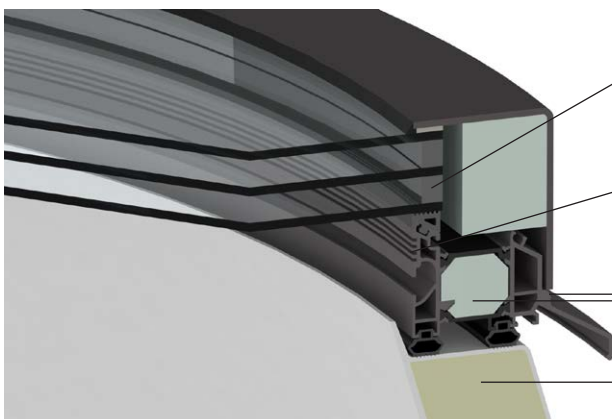

"Warm edge" (spacers between the panes, made of materials with low thermal conductivity) **as a standard feature**

TAD – Thermo active design:

Kink-free isothermal curve in the profile system

Aluminium border frame with optimised insulation core

Heat-insulated upstand made of glass-fibre reinforced composite: Manufactured without joints (optional) and with a continuous insulation core made of PU foam, 50 mm thick



LAMILUX

GLASS SKYLIGHT FE PYRAMID/HIPPED

These pyramid-shaped or hipped roof-shaped skylights enhance your flat roof visually not only through their striking shapes, but also through their delicate design from inside and outside - also thanks to elegant, narrow cross-bar profiles.

The Glass Skylights do not require visible screw connections and can be individually designed in their dimensions. The same applies to the colours of the surrounding profiles, which can be adapted to the overall concept of the building.

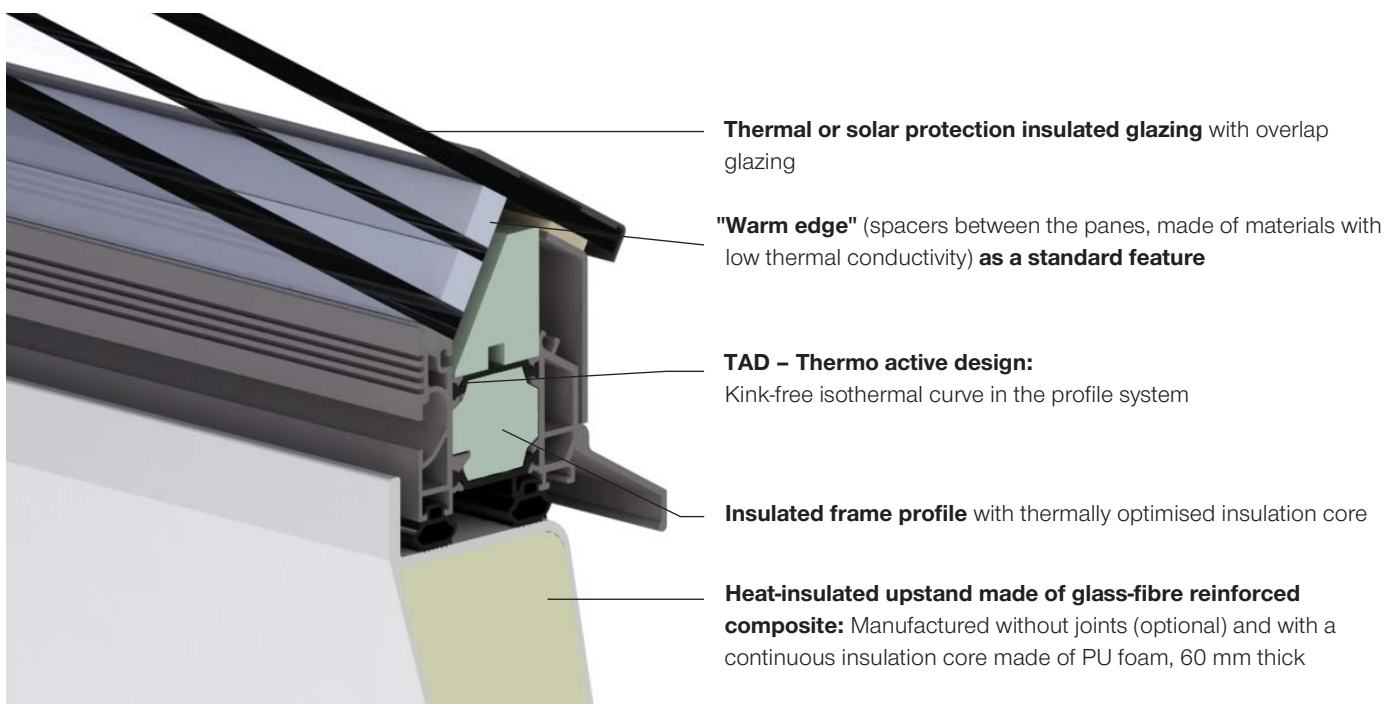



LAMILUX GLASS SKYLIGHT FE PASSIVHAUS

The energetic qualities of building products are the measure of all things in modern building. The Passive House demands the highest standard here – and the LAMILUX Glass Skylight FE Passivhaus and LAMILUX Glass Skylight FE Passivhaus+ are the world's first skylights at this energy efficiency level to be certified by the Passive House institute in Darmstadt.

Not least because of its triple step sealing system, its optimised insulation core and the warm edge with super spacer in the standard triple glazing or optional quadruple glazing, it fulfils the highest Passive House efficiency class: phA advanced component. The special feature is its heat transfer coefficient USL of 0.68 W/(m²K). Further advantages are high solar heat gains with simultaneously minimised condensate risk. The LAMILUX Glass Skylight FE Passivhaus+ meets the criteria for the "cold" climate region and is therefore the first skylight in the world to be suitable for passive houses in Scandinavia as well as in many regions of Austria, Switzerland and Eastern Europe.

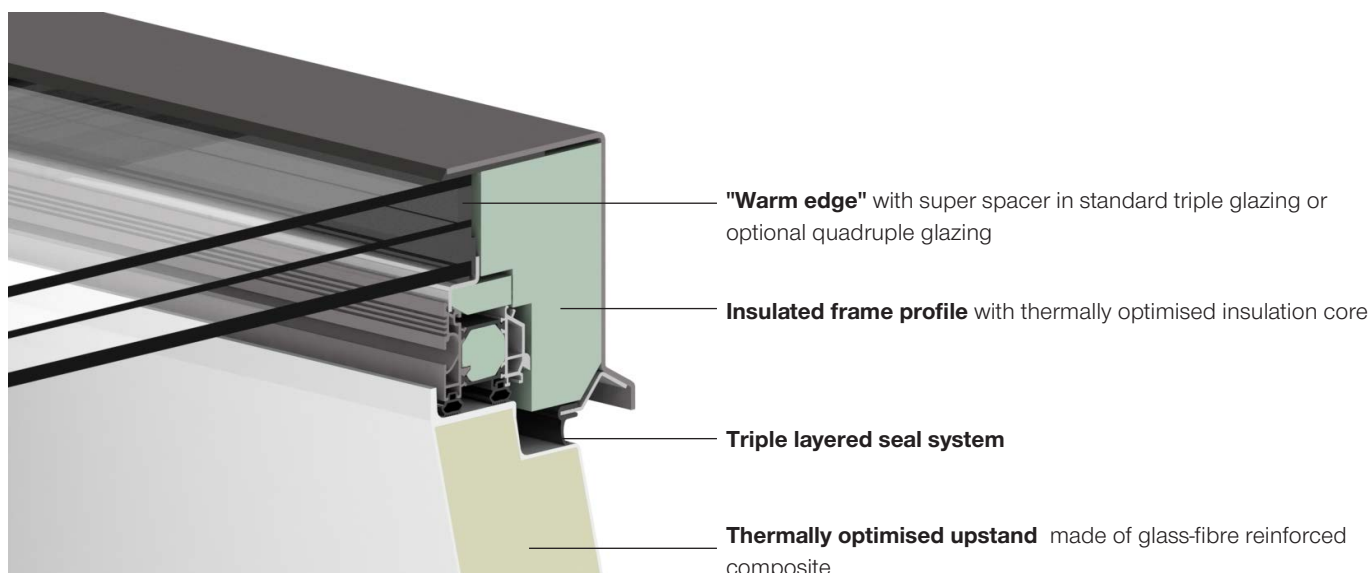



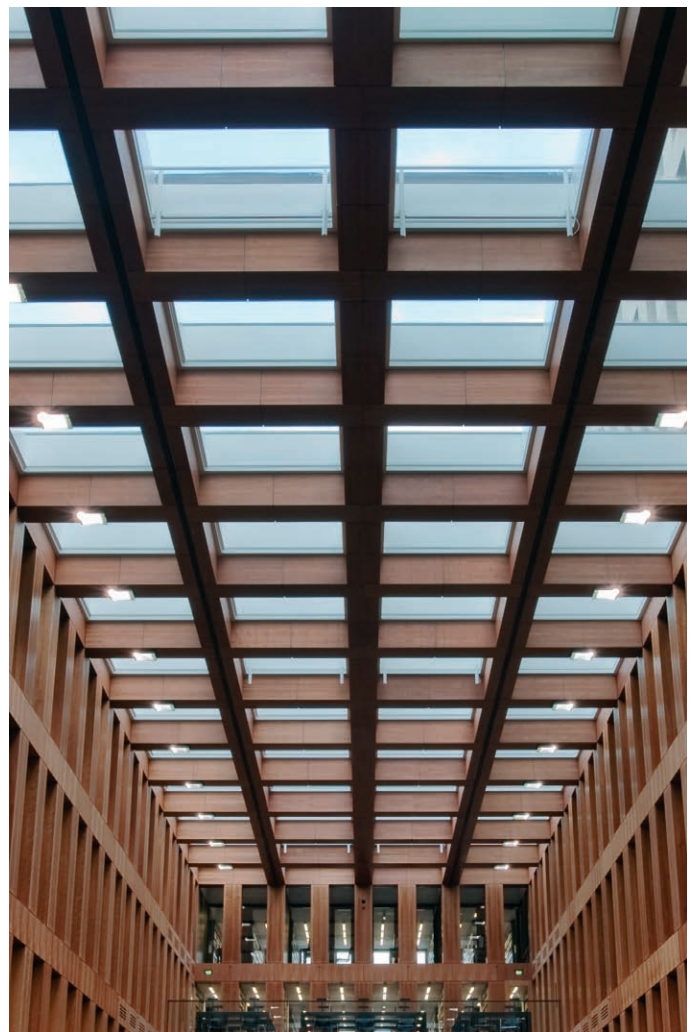

APARTMENT, BERLIN

Project:

Creation of a luxury living space with an exclusive ambience thanks to generous daylight intake, controllable ventilation and convenient access to the roof terrace

Systems:

- One LAMILUX Flat Roof Access Hatch Comfort Duo, horizontally opening flat roof element (automatic opening and closing)
- Compact, extremely energy-efficient overall structure, placed on a glass-fibre reinforced composite upstand with an integrated core insulation block
- Low-noise sliding on stainless steel telescopic rails

HUMBOLDT UNIVERSITY, BERLIN

Project:

Large-area, natural illumination of the central library and reading area of the new building with high demands on the thermal insulation of the skylights

Systems:

- 92 LAMILUX Glass Skylight FE 3° elements, dimensions 250 x 250 cm
- Design partly as natural aeration and ventilation and with SHEV function
- Upstand structures made of glass-fibre reinforced composite with inside trimming made of coated sheet steel
- Sun protection glazing with 50% light transmittance and 17% energy transmission



NORRKÖPING SCHOOL, SWEDEN

Project:

Conversion of a former industrial building into a school building; Supply of the building with natural daylight even on cloudy winter days

Systems:

- LAMILUX Glass Skylight FE Pyramid in the dimensions 180 x 180 cm with a Ug value of 1.1 W/(m²K) and a sound insulation value of 35 dB
- Upstands made of glass-fibre reinforced composite, 50 cm in height
- Condensate detector



MILTON KEYNES UNIVERSITY HOSPITAL, ENGLAND

Project:

New construction of an administration building with a focus on aesthetic, natural lighting

Systems:

- 17 LAMILUX Smoke Lift Glass Skylight F100
- Six LAMILUX Glass Skylights FE Circular in ventilated design
- Six motors in special design for Glass Skylights
- Wind and rain sensor set
- SHEV central units and CO₂ alarm stations

LAMILUX

FLAT ROOF ACCESS HATCH COMFORT

What the garden is to one person, the roof terrace is to another – preferably with direct access. A new dimension of roof access is offered by the LAMILUX Flat Roof Access Hatch Comfort range. For attic apartments, a previously unattainable light incidence is realised and an even easier access to the roof is created.

The indoor climate also benefits from the systems' high energy efficiency and unrestricted use as a ventilation device. Our roof hatches are delivered to the construction site completely pre-assembled, lifted onto the roof using a crane provided by the customer and then installed very straightforwardly and quickly.



LAMILUX Flat Roof Access Hatch Comfort Solo

Here, the roof access hatch of 120 x 350 cm opens horizontally by means of a built-in rack and pinion drive. The triple glazing is enormously energy-efficient, the 6° inclination ensures a self-cleaning effect and the drive units are concealed.



LAMILUX Flat Roof Access Hatch Comfort Duo

This roof hatch opens two wings of 60 x 300 cm each to the long sides. It can also be equipped with high-quality functional glass and can be used as a ventilation device. The element has no disturbing edges or visible drive units on the inside and is insulated very well.



LAMILUX Flat Roof Access Hatch Comfort Swing

The roof hatch opens its 300 or 350 cm long glass element hydraulically by 84° using a key switch. Within 25 seconds, it opens the approx. 100 cm wide way onto the roof. The 5° inclination ensures an ideal self-cleaning effect.



LAMILUX Flat Roof Access Hatch Comfort Square

With this roof hatch, hydraulic drives open the 4 m² glass surface up to 70° within 45 seconds. Due to the square shape, spiral or platform staircases can be used, which especially meets purist design standards.



reddot winner 2021

LAMILUX GLASS SKYLIGHT FIRE RESISTANCE REI 30, REI 60 AND REI 90

Our fire resistant windows offer strong protection in case of fire. They defy fire and heat for a certain period of time. The duration for which a fire resistant window must withstand the fire increases with constantly stricter fire protection requirements.

Our Glass Skylight Fire Resistance is installed when required by the fire protection concept. It is delivered to the construction site as a factory pre-assembled element on a steel upstand and only needs to be sealed on site. Larger dimensions are possible up to the product variant Glass Roof Fire Resistance REI 60 and are installed on site by the technician.

With our Glass Skylight Fire Resistance REI 90, we offer extended protection against fire and heat for at least 90 minutes, which prevents flames from spreading to other parts of the building in case of fire. In addition, our Glass Skylights Fire Resistance have undergone a load test under real conditions to ensure their stability. The element is inclined by 5° to ensure optimal water and dirt drainage and can be installed in roof inclinations of up to 15°.

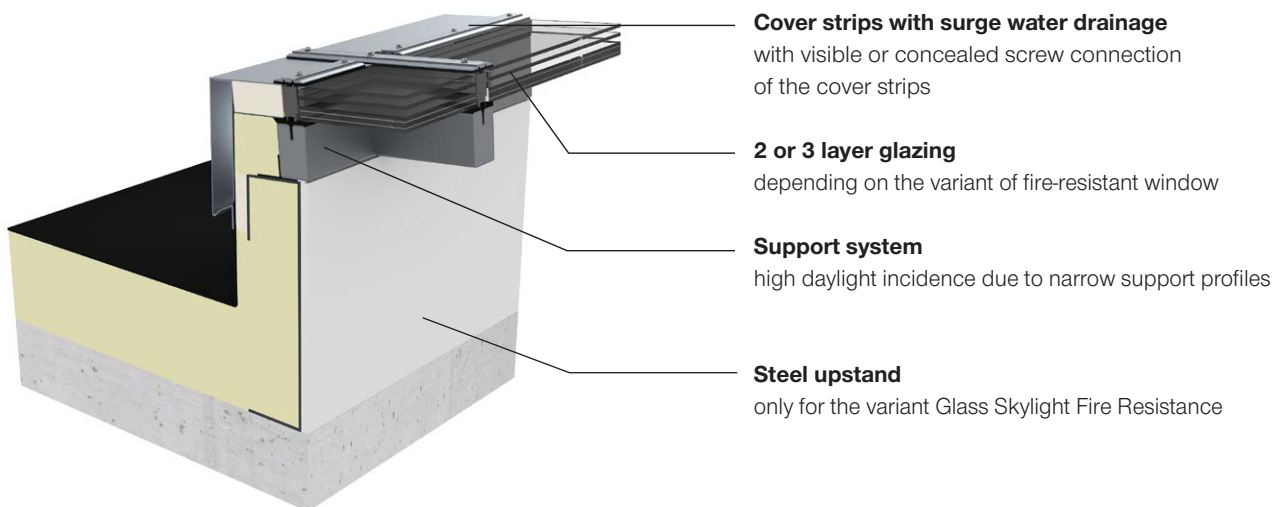





ALL BENEFITS AT A GLANCE

OPTIMISED SEALING AND DRAINAGE SYSTEM

Efficient ventilation of glazing rebates and controlled drainage of water and condensate

Overlapping, multi-layered sealing system, designed without direct joints and a secondary drainage system in the inner sealing layer

Joint-free, continuous drainage level on the mullion/transom

Increase and improvement of the surface temperature on the glass edge and subsequent reduction in risk of condensation

PRODUCT VARIETY IN HIGH QUALITY STANDARDS

Various fire protection windows available in all fire resistance classes

German Design Award 2023 in the category „Excellent Product Design - Building and Elements“ for our new Glass Skylight Fire Resistance REI 90

Visible elements of the supporting structure with RAL coatings

Visible or concealed screw connection of the ceiling strips possible

SAFETY

Fire resistance with the functional integrity of the complete system certified to 30 minutes / 60 minutes / 90 minutes

Resistance to external fire exposure from flying sparks and radiating heat with classification B_{ROOF} (t1) as per DIN EN 13501-5

Classification according to EN 13501-2

ACTIVE ENERGY MANAGEMENT

Reduction of heat loss in the frame

Optimised building energy balance through improved thermal insulation







Combination of fire protection properties and energy benefits

LAMILUX GLASS SKYLIGHT F100 & SMOKE LIFT GLASS SKYLIGHT FE

The LAMILUX Smoke Lift Flat Glass Skylight F100 and LAMILUX Smoke Lift Glass Skylight FE offer new architectural possibilities for high-quality administrative buildings. It combines the advantages of flat roof skylights with those of an electrical smoke and heat exhaust ventilator according to DIN EN 12101-2.

It achieves excellent heat and sound insulation values and, in the case of the FE version, the aluminium frame can also be designed in freely selectable RAL colours. The natural smoke and heat exhaust ventilator offers you safety and comfort for your workspaces.

Temperature parameters according to DIN EN 12101-2 and test results Our NSHEVs reliably open into the SHEV position in less than 60 seconds...

	... and ensure high smoke discharge volumes	Flow rate coefficient C_v between 0.60 and 0.71; Aerodynamically effective opening surface A_a between 0.6 m ² and 2.84 m ² *
	... after endurance test – 1,000 times in SHEV position and 10,000 times in ventilation position	RE 1000 Ventilation 10,000
	... under snow load	SL 1000 to SL 2000
	... down to indoor temperature of -15 °C	T(-15)
	... after exposure to wind (up to 1500 N/m ²)	WL 1500
	... when exposed to fire	B 300

How your benefit

- Multi-stage ventilation fitted as standard
- Easy to close after false signal release
- Structure completely free of thermal bridges with a U_w value between 1.3 and 1.0 W/(m²K), depending on the glazing (as per DIN EN ISO 10077-1 for a reference element measuring 120 x 120 cm)
- Thermally insulated, joint-free GRP upstand, 30, 40 or 50cm in height, with U-values between 0.5 W/(m²K) and 0.9 W/(m²K)
- Complies with DIN 18234 requirements: Prevents fire spreading on the roof without additional measures
- Available as a roof access hatch as an option
- Available with 24 V or 48 V drives

LAMILUX Smoke Lift Glass Skylight F100

- Permanent fall-through protection according to GS-Bau 18
- Available with double or triple insulating glazing with U_g values between 1.1 and 0.95 W/(m²K)
- Hard roofing, no burning droplets

LAMILUX Smoke Lift Glass Skylight FE

- Tested fall-through protection according to DIN 18008-6
- Available with double or triple insulating glazing with U_g values between 1.1 and 0.6 W/(m²K)

*valid for F100 up to 1,42 m²



LAMILUX RENOVATION SOLUTIONS

Renovations can be carried out for a wide variety of reasons. For example, to replace a damaged upper part, to better insulate the roof or to improve the energy efficiency and appearance of flat skylights. LAMILUX offers made-to-order solutions for this – as well as for all other renovation cases.

This includes for example the renovation frame for easy replacement of skylights. If, in addition, an energetic renovation of the roof is carried out, this is usually accompanied by an increase in the roof structure. In this case, the additional extension elements are the right choice: Existing upstands can be easily extended with it. Thanks to the made-to-order renovation solutions, LAMILUX can extend any onsite upstand. Most importantly: Individual consultation in individual cases.

LAMILUX Glass Skylight F100 or LAMILUX Glass Skylight FE

LAMILUX flat roof window

optional extension element

renovation frame

Existing on-site upstand

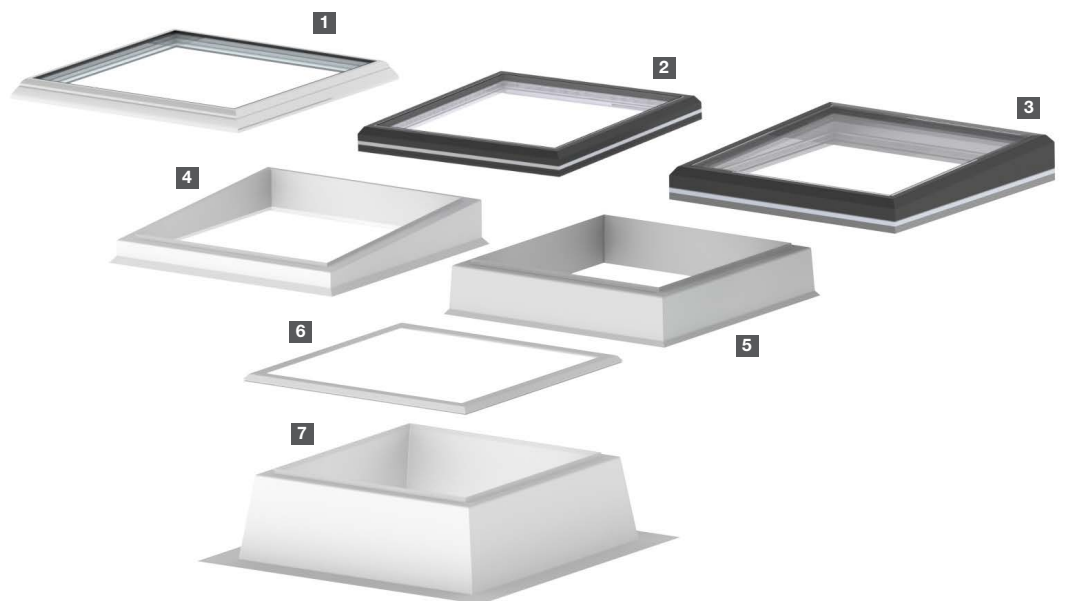

1 LAMILUX Glass Skylight F100

2 LAMILUX Glass Skylight FE

3 LAMILUX Glass Skylight FE 3°

4 GRP Heightening Element 5°

5 GRP Heightening Element

6 Renovation Frame 1 or 11

7 Existing on-site upstand

LAMILUX UPSTAND: IDEAL STRUCTURAL ATTACHMENT

The upstand is a key component in the whole LAMILUX Glass Skylights. Constantly further developed in terms of stability and heat-insulating properties, the upstand forms the base for the structure. It provides a thermally optimum connection to the building structure.

Upstands are available in GRP (glass-fibre reinforced plastic), aluminium and steel sheet.

A big advantage for the builder is the complete pre-assembly of the products we deliver. This saves time during installation on the roof and ensures fast closing of the roof opening. The LAMILUX GRP upstands also offer many options for customised roof mounts.



Heat-insulated base flange

The base flange made of glass-fibre reinforced composite and thermally insulated with PU foam is characterised by very good insulating properties and can be individually adapted to the height of the roof insulation. This upstand offers the possibility of connecting bitumen roofing membranes directly to the base flange in a system-compatible manner, so that time-consuming raising of the roofing membrane at the upstand is no longer necessary. The thermally insulated base flange is also available in combination with the rigid PVC connecting rail.



Hard PVC connecting rail

Hard PVC connecting rail is circumferentially laminated onto the base flange at the factory and seal-welded in the corners. This upstand offers the possibility of welding PVC roofing membranes directly to the 80 mm wide PVC connecting rail at the base flange. In this way, a material-locking, all-round tight connection with the upstand is ensured. The rigid PVC connecting rail is also available without the thermally insulated base flange.

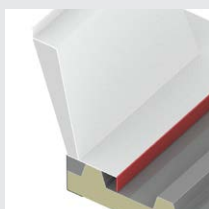

Bevelled base flange

A variant of the GRP skylight base with a base flange bevelled on both sides is available for structural attachment to profile roofs. For further requirements, e.g. on-site upstand, it is also available in a four-sided bevelled design.

Glazing types

Heat protection insulation glazing

F100

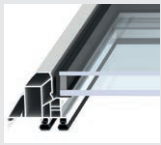

W102 DOUBLE TSG

Ug value: approx. 1,1 W/(m²K)
 Noise-proofing value: approx. 38 dB
 Translucency: approx. 80 %
 Energy transmission: approx. 62 %

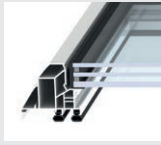

W701 TRIPLE TSG

Ug value: approx. 0,97 W/(m²K)
 Noise-proofing value: approx. 39 dB
 Translucency: approx. 72 %
 Energy transmission: approx. 51 %

Heat protection insulation glazing with matt, light-coloured film

F100

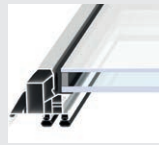

W103 DOUBLE TSG (MHF)

Ug value: approx. 1,1 W/(m²K)
 Noise-proofing value: approx. 38 dB
 Translucency: approx. 54 %
 Energy transmission: approx. 59 %

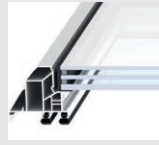

W702 TRIPLE TSG (MHF)

Ug value: about 0,97 W/(m²K)
 Noise-proofing value: approx. 39 dB
 Translucency: approx. 49 %
 Energy transmission: approx. 50 %

Solar protection insulation glazing

F100

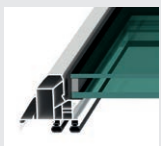

S109 DOUBLE TSG, 60/30

Ug value: approx. 1,1 W/(m²K)
 Noise-proofing value: approx. 38 dB
 Translucency: approx. 61 %
 Energy transmission: approx. 33 %

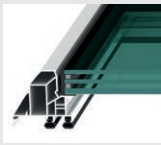

S717 TRIPLE TSG, 60/30

Ug value: approx. 0,95 W/(m²K)
 Noise-proofing value: approx. 39 dB
 Translucency: approx. 55 %
 Energy transmission: approx. 30 %

Solar protection insulation glazing with matt, light-coloured film

F100

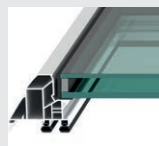

S110 DOUBLE TSG, 60/30 (MHF)

Ug value: approx. 1,1 W/(m²K)
 Noise-proofing value: approx. 38 dB
 Translucency: approx. 40 %
 Energy transmission: approx. 32 %

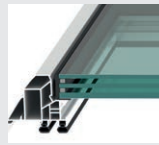

S718 TRIPLE TSG, 60/30 (MHF)

Ug value: approx. 0,95 W/(m²K)
 Noise-proofing value: approx. 39 dB
 Translucency: approx. 37 %
 Energy transmission: approx. 29 %

Heat protection insulation glazing

FE

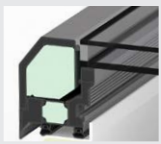

W102 DOUBLE TSG

Ug value: approx. 1,1 W/(m²K)
 Noise-proofing value: approx. 38 dB
 Translucency: approx. 80 %
 Energy transmission: approx. 62 %

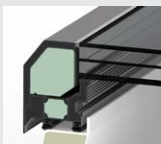

W110 TRIPLE TSG

Ug value: approx. 0,6 W/(m²K)
 Noise-proofing value: approx. 39 dB
 Translucency: approx. 72 %
 Energy transmission: approx. 51 %

Heat protection insulation glazing with matt, light-coloured film

FE

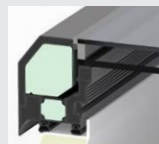

W103 DOUBLE TSG (MHF)

Ug value: approx. 1,1 W/(m²K)
 Noise-proofing value: approx. 38 dB
 Translucency: approx. 54 %
 Energy transmission: approx. 59 %

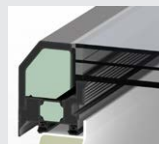

W303 TRIPLE TSG (MHF)

Ug value: approx. 0,6 W/(m²K)
 Noise-proofing value: approx. 39 dB
 Translucency: approx. 49 %
 Energy transmission: approx. 50 %

Solar protection insulation glazing

FE

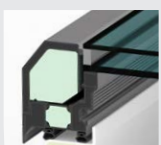

S109 DOUBLE 60/30 TSG

Ug value: approx. 1,1 W/(m²K)
 Noise-proofing value: approx. 38 dB
 Translucency: approx. 60 %
 Energy transmission: approx. 33 %

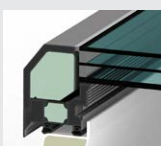

S117 TRIPLE 60/30 TSG

Ug value: approx. 0,6 W/(m²K)
 Noise-proofing value: approx. 39 dB
 Translucency: approx. 55 %
 Energy transmission: approx. 30 %

Solar protection insulation glazing with matt, light-coloured film

FE

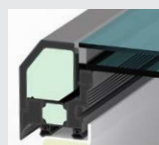

S101 DOUBLE 50/25 TSG

Ug value: approx. 1,1 W/(m²K)
 Noise-proofing value: approx. 38 dB
 Translucency: approx. 52 %
 Energy transmission: approx. 28 %

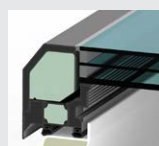

S121 TRIPLE 50/25 TSG

Ug value: approx. 0,6 W/(m²K)
 Noise-proofing value: approx. 39 dB
 Translucency: approx. 45 %
 Energy transmission: approx. 25 %

TSG: (toughened safety glass) Has increased shock and impact resistance due to special heat treatment in the manufacturing process. If broken, the glass will shatter into many small pieces without sharp edges, which reduces the risk of injury.

MHF: (Matt bright foil) By using an opal foil the incident light is scattered and a direct glare effect is avoided.

Opener variants

Chain drives



24 volt / 230 volt chain drive

- Voltage: 24 volt, 230 volt
- Lift heights: 300 mm, 500 mm



Concealed chain drive

- Voltage: 24 volt, 230 volt
- Lift heights: 250 mm, 300 mm
- Concealed installation integrated in upstand (Glass Skylight F100)
- Concealed installation in frame (with Glass Skylight FE version)

Linear drives



230 volt linear motor

- Voltage: 230 volt
- Lift heights: 300 mm, 500 mm



24 volt linear motor

- Voltage: 24 volt
- Lift heights: 300 mm, 500 mm

Hand crank



Manual opening

- Solo arrangement
- Hand crank for upstand spindle

Concealed cable duct



Integration

- Cable routing invisible from the inside integrated in the upstand

Accessories

Optional equipment



Reflective

- The light transmittance of the daylight element is increased by up to 50% due to the patented principle of cladding with highly reflective aluminium material
- Up to 33% savings in energy used for artificial light
- Elegant surface finish gives high-quality interior appearance

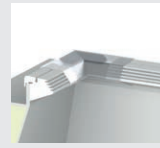

LED

- LEDs with high-quality daylight character
- Colour selection: Warm white 2700K, Neutral white 4000K
- Concealed cable routing in the upstand

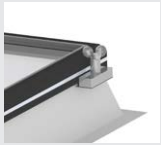

Wind and rain sensor set

- For automatic closing in wind and rain
- Operated as a group and individually
- Pre-assembled at the factory on the border frame

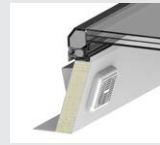

Small space ventilation unit

- Option for LAMILUX-GFK upstands that are 30, 40 and 50 cm in overall height, incl. weather protection hood
- Not available for round design



Insect protecting grating

- Integration of the protective device into the upstand
- Close to complete prevention of insects entering the building



Reed contact

- Integration of the magnetic switch in the frame profile
- Signalling of the opening status by means of a contactless switching process



Roof Access Hatch

- Access from inside the building to the roof
- With gas springs or electric drive
- Optionally with lockable window handle or spring-loaded locking pin

Sun protection

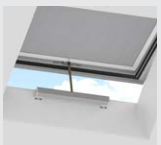

Internal shadow film blind

- Integration on the underside of the upper part
- Pre-assembled at the factory
- White-coated mounting frame
- Concealed cable routing in the upstand



Internal film roller blind

- Integration on the underside of the upstand
- Version with safety pull straps
- Optionally with remote control
- White inside

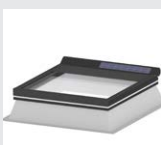

External aluminium roller blind

- Optionally available with semi-transparent louvers
- Can be supplied in a variety of colours
- Optionally with integrated solar module and remote control



External awning

- With noise-optimised running-in gliders
- Optionally with remote control
- Concealed cable routing in the upstand

Accessories

Smoke extraction



LAMILUX SHEVS STAIRCASE SET

For ventilated flat roof windows consisting of:

- SHEV control unit with emergency power supply
- 24 volt drive with 500 mm lifting height
- Two SHEV buttons
- One fan button

Quality

- + Outstanding air-tightness due to the double balloon-type seal: Performance class 4 – tested in accordance with DIN EN 12207
- + Watertightness as per DIN EN 12208, Class E 1950
- + High resistance to wind load according to EN 12211 class C 4 (for LAMILUX Glass Skylight F100) and class C 5 (for LAMILUX Glass Skylight FE)
- + Passive fire protection: Compliance with DIN 18234 for the prevention of fire spread on rooftops without additional measures
- + Resistance to external fire damage from flying sparks and radiating heat with classification B,roof(t1) according to DIN EN 13501-5
- + Life-cycle assessment made easy: Comprehensive environmental product declaration according to ISO 14025 and EN 15804 (EPD - Modules A1 - D)
- + Certified sustainable building – Green Building Profile (DGNB, LEED, BREEAM)

Available sizes

LAMILUX Glass Skylight F100











Structural roof opening size in cm	Standard position of lock	Daylight area\ lighting area in m ²	Structural roof opening size in cm	Standard position of lock	Daylight area\ lighting area in m ²
60 / 60		0,18	90 / 145		0,91
60 / 90		0,30	100 / 100		0,67
60 / 120		0,43	100 / 150		1,08
70 / 135		0,61	120 / 120		1,04
80 / 80		0,38	120 / 150		1,35
80 / 150		0,82	125 / 125		1,14
90 / 90		0,52	140 / 140		1,49
90 / 120		0,73	150 / 150		1,74

LAMILUX Glass Skylight F100 Circular

Diameter in cm	Daylight area\ lighting area in m ²	Diameter in cm	Daylight area\ lighting area in m ²
60	0,23	120	0,82
80	0,30	150	1,37
90	0,41	180	2,06
100	0,53		

Available sizes

LAMILUX Glass Skylight FE and LAMILUX Glass Skylight FE 3° | Pyramid | Hipped













Structural roof opening size in cm	Standard position of lock	Daylight area\ lighting area in m ²	Structural roof opening size in cm	Standard position of lock	Daylight area\ lighting area in m ²
50/100		0,26	120/240		2,26
50/150		0,42	120/250		2,37
60/60		0,18	120/270		1,14
60/90		0,30	125/125		2,48
60/120		0,43	125/250		1,49
70/135		0,61	140/140		2,88
80/80		0,38	150/150		1,74
80/150		0,82	150/180		2,14
90/90		0,52	150/200		2,40
90/120		0,73	150/210		2,53
90/145		0,91	150/240		2,93
100/100		0,67	150/250		3,06
100/150		1,08	150/270		3,33
100/200		1,49	150/300		3,72
100/240		1,82	180/180		2,62
100/250		1,90	180/240*		3,60
100/300		2,31	180/250*		3,76
120/120		1,04	200/200		3,31
120/150		1,35	250/250*	—	5,38
120/180		1,65			

*only for LAMILUX Glass Skylight FE

LAMILUX Glass Skylight FE Circular

Diameter in cm	Daylight area\ lighting area in m ²	Diameter in cm	Daylight area\ lighting area in m ²
90	0,41	180	2,06
100	0,53	200	2,60
120	0,82	220	3,20
150	1,37		

LAMILUX Roof Access Hatch

Structural roof opening size in cm	Standard position of lock	Daylight area \ lighting area in m ²	Structural roof opening size in cm	Standard position of lock	Daylight area \ lighting area in m ²
60 / 90		0,30	90 / 120		0,73
60 / 120		0,43	90 / 145		0,91
70 / 135		0,61	100 / 100		0,67
80 / 80		0,38	100 / 150		1,08
80 / 150		0,82	120 / 120		1,04
90 / 90		0,52	120 / 150		1,35

LAMILUX Smoke Lift Glass Skylight F100

Structural roof opening size in cm	Aa value in m ²	Structural roof opening size in cm	Aa value in m ²
100/100	0,60	125/125	0,97
100/150	0,90	150/150*	1,42
120/120	0,88	150/150**	1,35
120/150	1,12		

* for double glazing

** for triple glazing

LAMILUX Smoke Lift Glass Skylight FE 0° | 3°

Structural roof opening size in cm	Aa value in m ²	Structural roof opening size in cm	Aa value in m ²
100/100	0,60	120/250	1,86
100/150	0,90	120/300	2,23
100/200*	1,24	125/125	0,97
100/200**	1,20	125/250	1,94
100/240	1,44	150/150*	1,42
100/250	1,53	150/150**	1,35
100/300	1,83	150/180	1,65
120/120	0,88	150/200	1,86
120/150	1,12	150/210	1,98
120/180*	1,36	150/240	2,27
120/180**	1,30	150/250	2,36
120/240	1,79	150/300	2,84

* for double glazing

** for triple glazing



Scan this to learn more about
LAMILUX skylights!

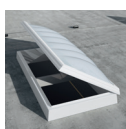

ROOFLIGHT F100 W



GLASS SKYLIGHT F100



GLASS SKYLIGHT FE



GLASS ARCHITECTURE



FLAT ROOF ACCESS HATCH



MIROTEC STEEL CONSTRUCTIONS



CONTINUOUS ROOFLIGHT B/S



RENOVATION



TRANSLUCENT FAÇADE AND ROOF



SMOKE AND HEAT EXHAUST
VENTILATION SYSTEMS



RODA LIGHT AND AIR TECHNOLOGY



MODULAR GLASS SKYLIGHT MS78

The technical data listed in this brochure correspond to the current status at the time of printing and are subject to change. Our technical specifications are based on calculations and supplier specifications, or have been determined by independent testing authorities within the scope of applicable standards.

Thermal transmission coefficients for our plastic glazing were calculated using the finite element method with reference values in accordance with DIN EN 673 for insulated glass. Taking into account practical experience and the specific characteristics of plastic, the temperature difference between the outer surfaces of the material was defined as 15 K. Functional values refer to test specimens and the dimensions used in testing only. We cannot provide any further guarantees of technical values. This particularly applies to changed installation conditions or if dimensions are re-measured on site.



LAMILUX Heinrich Strunz GmbH

Zehstraße 2 · PO Box 1540 · 95111 Rehau · Tel.: +49 (0) 92 83 / 5 95-0 · Fax +49 (0) 92 83 / 5 95-29 0

E-Mail: information@lamilux.de · www.lamilux.com

